

MCC204 Power Amplifier



MCC204

WARNING - TO REDUCE RISK OF FIRE OR ELECTRICAL SHOCK, DO NOT EXPOSE THIS EQUIPMENT TO RAIN OR MOISTURE.

NO USER-SERVICEABLE PARTS INSIDE. REFER SERVICING TO QUALIFIED PERSONNEL.

To prevent the risk of electric shock, do not remove bottom cover. No user serviceable parts inside.

IMPORTANT SAFETY INSTRUCTIONS!

PLEASE READ THEM BEFORE OPERATING THIS EQUIPMENT.

General:

1. Read these instructions.
2. Keep these instructions.
3. Heed all warnings.
4. Follow all instructions.
5. **Warning: To reduce risk of fire or electrical shock, do not expose this equipment to rain or moisture. This unit is capable of producing high sound pressure levels. Continued exposure to high sound pressure levels can cause permanent hearing impairment or loss. User caution is advised and ear protection is recommended when playing at high volumes.**
6. Disconnect this equipment when unused for long periods of time.
7. Only use attachments/accessories specified by the manufacturer.

Installation:

8. Do not block any ventilation openings. Install in accordance with the manufacturer's instructions.
9. Do not install near any heat sources such as radiators, heat ducts or other equipment that produce heat.
10. Do not use this equipment near water.
11. Do not expose this equipment to dripping or splashing and ensure that no objects filled with liquids are placed on the equipment.
12. Do not mount this product with an unstable bracket as the equipment may fall, causing serious injury to a person, and serious damage to the product.

Connection:

13. Route DC power cords so that they are not likely to be pinched by items placed upon or against them, paying particular attention to the point where they enter the instrument.

Care of Equipment:

14. Clean only with dry cloth.
15. Do not permit objects or liquids of any kind to be pushed, spilled and/or fall into the equipment through enclosure openings.

Repair of Equipment:

16. Refer all servicing to qualified service personnel. Servicing is required when the equipment has been damaged in any way, such as power-supply cord or plug is damaged, liquid has been spilled or objects have fallen into the equipment, the equipment has been exposed to rain or moisture, does not operate normally, or has been dropped.
17. Do not attempt to service beyond that described in the operating instructions. All other service should be referred to qualified service personnel.
18. When replacement parts are required, be sure the service technician has used replacement parts specified by McIntosh or have the same characteristics as the original part. Unauthorized substitutions may result in fire, electric shock, or other hazards.
19. Upon completion of any service or repairs to this product, ask the service technician to perform safety checks to determine that the product is in proper operating condition.

Thank You

Your decision to own this McIntosh MCC204 Four Channel Power Amplifier ranks you at the very top among discriminating music listeners. You now have “The Best.” The McIntosh dedication to “Quality,” is assurance that you will receive many years of musical enjoyment from this unit.

Please take a short time to read the information in this manual. We want you to be as familiar as possible with all the features and functions of your new McIntosh.

Please Take A Moment

The serial number, purchase date and McIntosh dealer name are important to you for possible insurance claim or future service. The spaces below have been provided for you to record that information:

Serial Number: _____

Purchase Date: _____

Dealer Name: _____

Technical Assistance

If at any time you have questions about your McIntosh product, contact your McIntosh dealer who is familiar with your McIntosh equipment and any other brands that may be part of your system. If you or your dealer wish additional help concerning a suspected problem, you can receive technical assistance for all McIntosh products at:

McIntosh Laboratory, Inc.
2 Chambers Street
Binghamton, New York 13903
Phone: 607-723-1545
Fax: 607-723-3636

Customer Service

If it is determined that your McIntosh product is in need of repair, you can return it to your dealer. You can also return it to the McIntosh Laboratory Service Repair department. For assistance on factory repair return procedure, contact the McIntosh Repair Department at:

McIntosh Laboratory, Inc.
2 Chambers Street
Binghamton, New York 13903
Phone: 607-723-3515
Fax: 607-723-1917

Table of Contents

Safety Instructions	2
Thank You	3
Please Take a Moment	3
Customer Service	3
Table of Contents	3
Introduction	4
Performance Features	4
Dimensions	5
Installation	6
Side Panel Cooling and Connections	7
How to Connect for Four Channels	8
How to Connect for Three Channels	9
How to Connect for Two Channels	10
How to Connect with Subwoofer Channel	11
Top Panel Controls, Displays and Switches	12
How to Operate	13
How to Operate in Four or Three Channel Mode	14
How to Operate in Two Channel or Subwoofer Mode	15
How to Replace the Fuses	16
Block Diagram	17
Specifications	18
Packing Instruction	19

General Notes

1. An optional McIntosh External Subwoofer Rotary Control, Model Number R1163, is available from your McIntosh Dealer.
2. Do not connect the Amplifier's Speaker Negative Terminal Connection directly to the Vehicle Chassis. Failure to observe this could result in damage to your Amplifier.
3. It is advisable to place an inline fuse as close as possible to the battery.
4. For additional connection information, refer to the owner's manual(s) for any component(s) connected to the MCC204 Amplifier.
5. There is a built-in turn on delay which will mute the speaker outputs for approximately two seconds when the amplifier is turned on.
6. It is very important that loudspeaker cables of adequate size be used in your music system, to ensure that there will be no power loss or heating. If your loudspeaker cables are 25 feet (7.62m) or less, use at least 16 Gauge wire size or larger.
7. The MCC204 Line Level OUTPUTs are wired as a “Y” connection with the INPUTs to pass the input signals on to additional amplifiers (keep cable lengths as short as possible). The McIntosh MX406 Control Center is capable of driving several additional power amplifiers with no degradation of the signal.
8. The MCC204 can accept speaker level inputs at its Input Jacks. Refer to the diagram for connection.

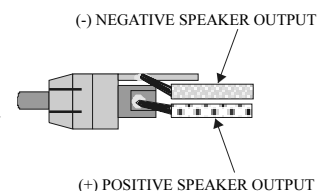

Introduction

Now you can take advantage of traditional McIntosh standards of excellence in the MCC204 Power Amplifier. Four 50 watt high current output channels will drive any high quality loudspeaker system to its ultimate performance. The MCC204 reproduction is sonically transparent and absolutely accurate. The McIntosh Sound is “The Sound of the Music Itself.”

Performance Features

• Power Output

The MCC204 consists of four separate power amplifier channels, each capable of 50 watts into 4 ohm speakers with less than 0.005% distortion.

• Four Bridgeable Channels

The MCC204 includes four 50 watt amplifier channels. Each pair of channels can be set in bridged configuration for 200 watts output into 4 ohm loudspeakers with less than 0.01% distortion.

• High Current Output

A peak output current of 15 amperes ensures that the MCC204 will successfully drive high quality loudspeakers, such as McIntosh, for a truly exciting sound experience.

• Equalizer and Variable Crossover Filters

The one band equalizer has a center frequency that is variable from 40 Hz to 2,000 Hz which can be either cut or boosted ± 12 db. 12dB per octave high pass filters with variable corner frequencies from 50Hz to 120Hz and 12dB per octave low pass filters with variable corner frequencies from 50Hz to 120Hz.

• Power Guard and Sentry Monitor

All channels include the patented McIntosh Power Guard circuit that prevents the amplifier from being overdriven into clipping with its harsh distorted sound that can also damage your valuable loudspeakers. McIntosh Sentry Monitor power output stage protection circuits are present on all channels to ensure the MCC204 will have a long and trouble free operating life.

• Speaker Protection

If for any reason, a DC (Direct Current) voltage appears at the speaker output terminals, a built-in circuit turns off the amplifier power supplies to prevent damage to your valuable loudspeakers.

• Thermal Protection with Multi-Speed Cooling Fan

Built-in thermal protection circuits guard against overheating which could shorten the normal long life expectancy of your McIntosh Power Amplifier. Cooling fan speed is controlled by temperature sensors attached to the interior of the extruded aluminum cooling tunnel. The fan is normally off. When needed, the fan will automatically switch on, and speed is increased as needed for additional cooling.

• Fully Discrete Design

The MCC204 has a fully complimentary double balanced amplifier design and is identical to that found in McIntosh’s leading home amplifiers.

• Balanced Inputs with Pass Through

The Balanced Inputs cancel out interference noise that is produced by other sources in the vehicle and can be directly connected to the bridged speaker output of any head unit. The MCC204 provides four line level outputs, for the convenience of connecting multi-amplifier systems.

• Remote Subwoofer Control and Line Output

The subwoofer level can be controlled via an external rotary control, which can be remotely mounted in the vehicle. A line level summed output is provided to drive an external subwoofer power amplifier. The inputs to both channels are summed for this output.

• Gold Plated Terminals

McIntosh provides gold plated input and output terminals on the amplifiers for superior corrosion resistance. It is a very important feature in the automotive environment. Speaker wires to 10 AWG and DC input wires to 4 AWG can be accommodated.

Dimensions

The following dimensions can assist in determining the best location for your MCC204. There is additional information on the next page pertaining to installing the MCC204 into your vehicle.

Top View of the MCC204

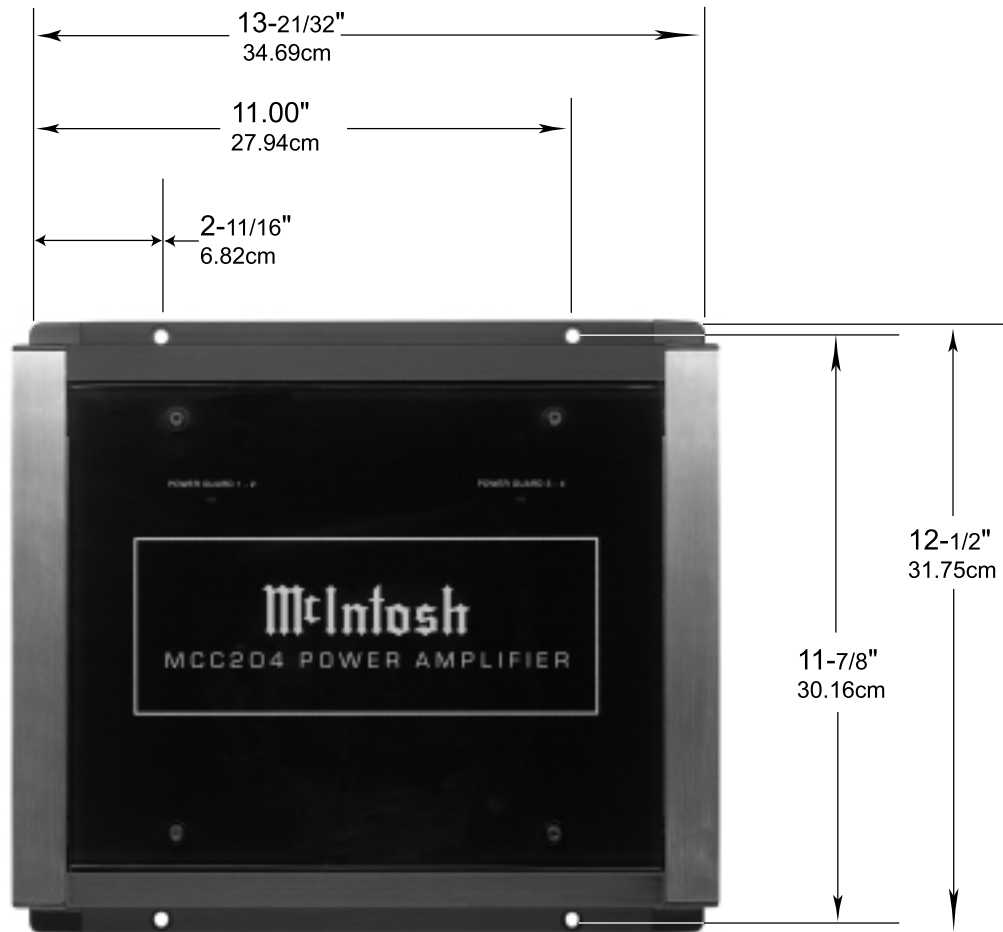

Side View of the MCC204

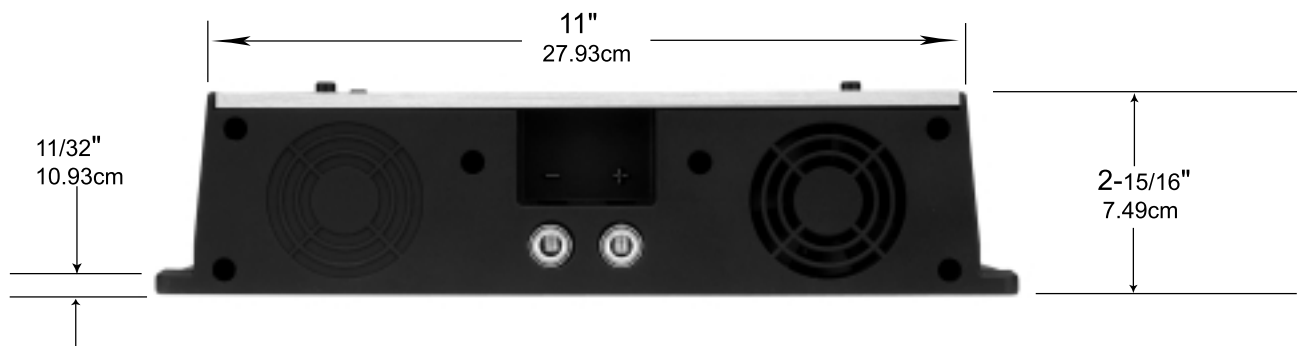

Installation

It is recommended that a professional who is skilled in all aspects of installation and operation install the MCC204 and any associated mobile audio equipment.

Amplifier Ventilation

Always provide adequate ventilation for the MCC204. The amplifier requires an adequate airflow into the cooling fan, which is located on the left side of the amplifier. The warm air exits the amplifier through vents on the heatsinks. See figure 1. Be sure to provide at least 1-1/2 inches clearance in front of the cooling fan and 1 inch clearance at the sides of the heatsinks.

The cooling fan is controlled by temperature sensors, attached to the interior of the tunnel. The fan is normally off. If the program material contains sustained loud passages demanding high power, the fan will turn-on to increase cooling. If cooling is still not sufficient, additional heating will shut down the amplifier's internal power supply completely and the Power Guard LEDs will light. The fan will continue to run and once normal temperatures are restored, operation will resume.

The amplifier can be mounted vertically or horizontally and may be located under a seat if adequate clearance is available. The preferred installation method is to mount the amplifier directly to the vehicle frame using the hardware supplied with the amplifier.

It is not recommended that the amplifier be mounted under the hood or in a location where it will be directly exposed to the elements. The openings in the fan housing and heat tunnel vents can allow internal components to be damaged by exposure to water, chemicals or any form of road dust or debris.

Removing the Glass Panel

To access the MCC204 Controls, remove the glass panel by removing the four hex bolts with the supplied 3/32" hex key. See figure 2. Attach the supplied suction cup to the top center of the glass panel and carefully raise it high enough to put your hand under. Temporarily place the removed glass panel in a safe place, remove the suction cup and save it for future use.

Removing the End Caps

To access the MCC204 Connecting Terminal Blocks, remove the Glass Panel first (the above step) and then remove the Phillips Screws holding the End Caps on both sides of the amplifier and lift the end caps off. See figure 3.

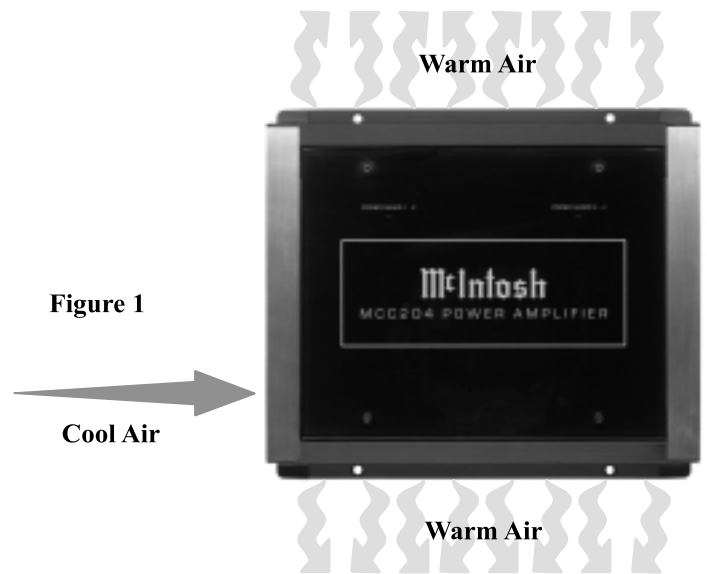

Figure 1

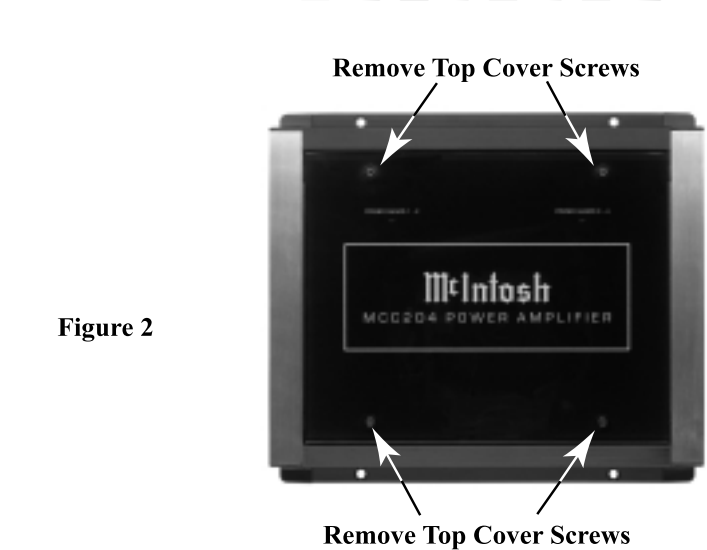

Figure 2

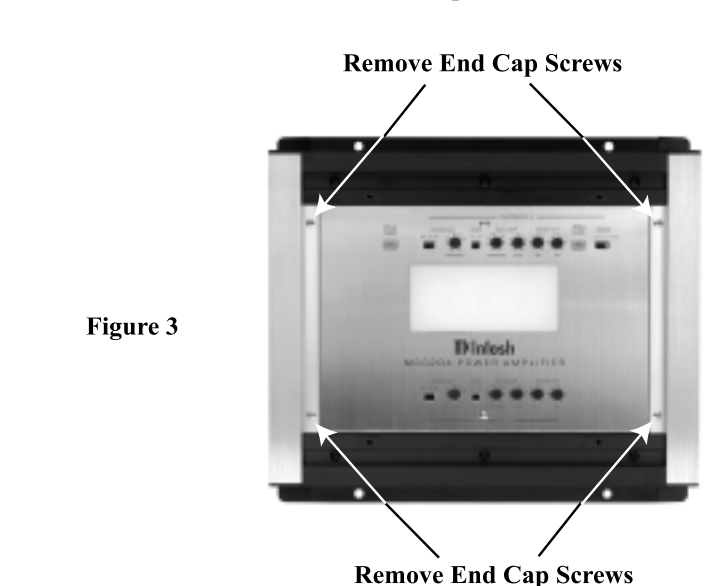
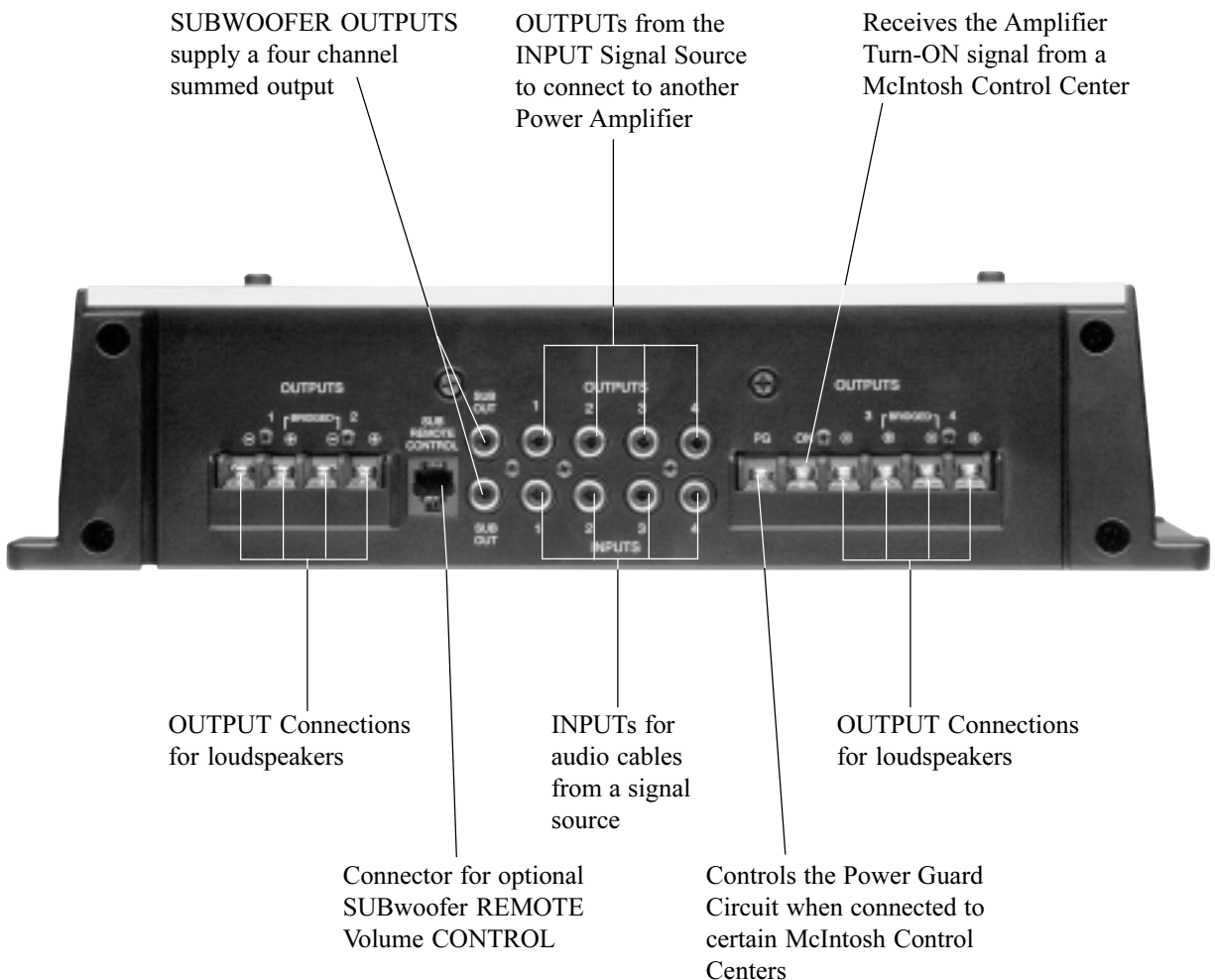
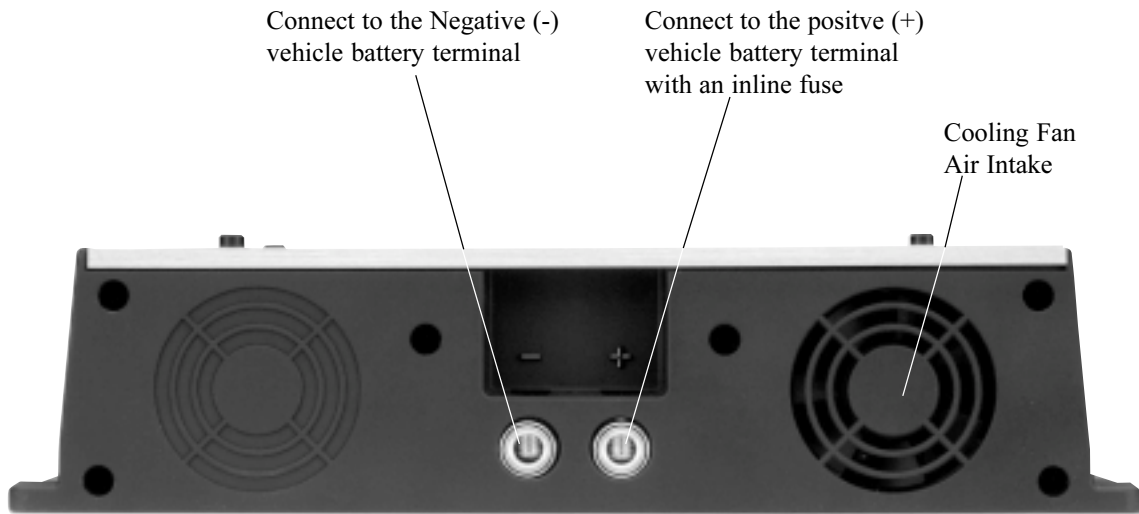

Figure 3

Side Panel Cooling and Connections



How to Connect for Four Channels

1. Connect a wire from the Control Center Amp On to the MCC204 ON Connector on the right side of the amplifier.

Note: All cables should be connected to the amplifier before connecting the DC power cables to the battery.

2. Connect a wire from a McIntosh Control Center with Power Guard to the MCC204 PG Connector on the right side of the amplifier.
3. Connect cables (up to 12AWG) from four separate loudspeakers, to the Amplifier's Channels 1, 2, 3 and 4 OUTPUT Terminals, being careful to observe the correct polarities.
4. Connect audio cables from the Control Center Outputs to the MCC204 Inputs 1, 2, 3 and 4.
5. Optional Connection illustrated below shows the SUB OUTPUT connected to a separate Subwoofer Power Amplifier and Subwoofer Loudspeaker.

Note: The Subwoofer Output Signal is at line-level, summed from all the Input Channels and is available regardless of the MCC204 Operating Mode used. The Subwoofer Output Level can be remotely controlled by the optional McIntosh External Subwoofer Rotary Control connected to the SUB REMOTE CONTROL jack on the MCC204.

6. Connect the MCC204 to the vehicle battery terminals using size 4AWG (maximum) cables.

Note: It is advisable to place an inline fuse of a suitable size as close as possible to the battery.

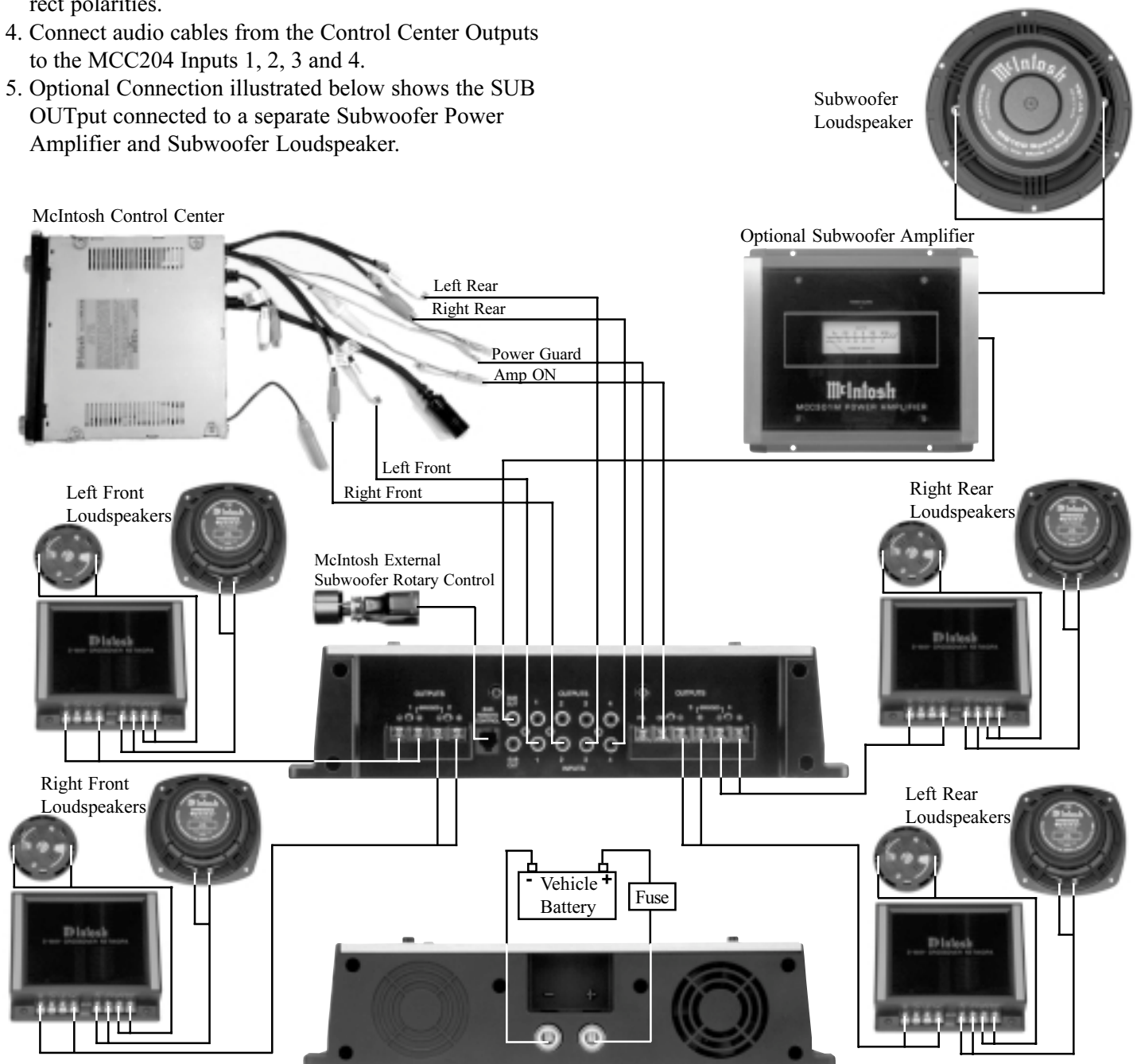

How to Connect for Three Channels

1. Connect a wire from the Control Center Amp On to the MCC204 ON connector on the right side of the amplifier.

Note: All cables should be connected to the amplifier before connecting the DC power cables to the battery.

2. Connect a wire from a McIntosh Control Center with Power Guard to the MCC204 PG connector on the right side of the amplifier.
3. Connect speaker cables (up to 12AWG) from a tweeter to the Amplifier's Channel 1 OUTPUT Terminals being careful to observe the correct polarities.
4. Connect speaker cables from a mid-range loudspeaker to the Amplifiers' Channel 2 OUTPUT Terminals, being careful to observe the correct polarities.

Note: The connecting information shown here is for a single channel of an audio system. For the other channel, connect a second MCC204 and loudspeakers in a similar manner.

5. Connect speaker cables from one woofer to the Amplifier's Channels 3 and 4 BRIDGED OUTPUT Terminals, being careful to observe the correct polarities.
6. Connect an audio cable from one of the control center outputs to the input of an external crossover.
7. Connect an audio cable from the external crossover TWEETER output to the MCC204 Channel 1 Input.
8. Connect an audio cable from the external crossover MID-RANGE output to the MCC204 Channel 2 Input.
9. Connect an audio cable from the external crossover WOOFER output to the MCC204 Channel 3 Input.

Note: Do not connect a cable to the MCC204 Channel 4 Input.

10. Connect the MCC204 to the vehicle battery terminals using size 4AWG (maximum) cables.

Note: It is advisable to place an inline fuse of a suitable size as close as possible to the battery.

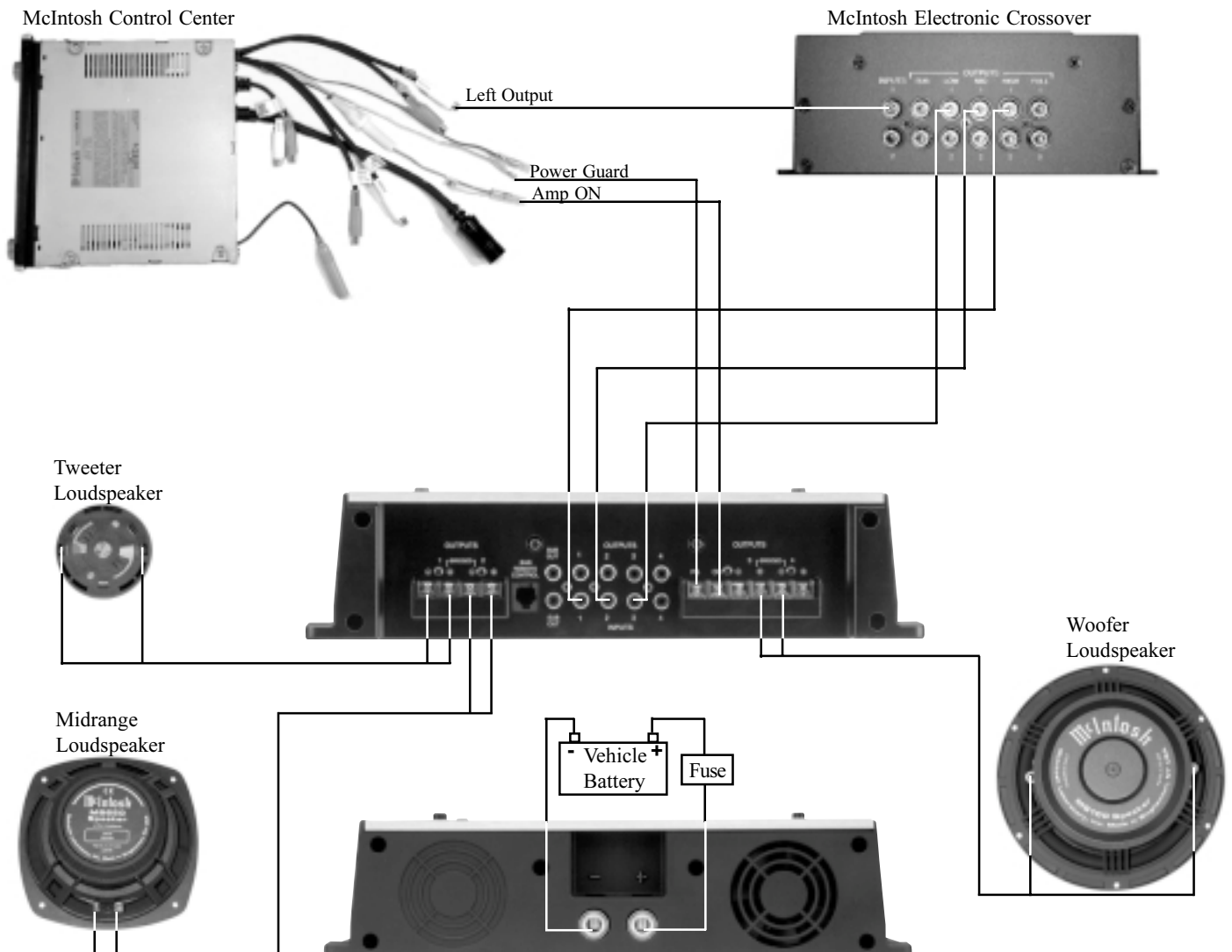

How to Connect for Two Channels

1. Connect a wire from the Control Center Amp On to the MCC204 ON Connector on the right side of the amplifier.

Note: All cables should be connected to the amplifier before connecting the DC power cables to the battery.

2. Connect a wire from a McIntosh Control Center with Power Guard to the MCC204 PG Connector on the right side of the amplifier.
3. Connect cables (up to 12AWG) from two separate loudspeakers, one to the Amplifier Bridged Channels 1 and 2 OUTPUT Terminals, and one to Bridged Channels 3 and 4 OUTPUT Terminals, being careful to observe the correct polarities.
4. Connect audio cables from the Control Center Outputs to the MCC204 Inputs 1 and 3.
5. Optional Connection illustrated below shows the SUB OUTPUT connected to a separate Subwoofer Power Amplifier and Subwoofer Loudspeaker.

Note: The Subwoofer Output Signal is at line-level, summed from all the Input Channels and is available regardless of the MCC204 Operating Mode used. The Subwoofer Output Level can be remotely controlled by the optional McIntosh External Subwoofer Rotary Control connected to the SUB REMOTE CONTROL jack on the MCC204.

6. Connect the MCC204 to the vehicle battery terminals using size 4AWG (Maximum) cables.

Note: It is advisable to place an inline fuse of a suitable size as close as possible to the battery.

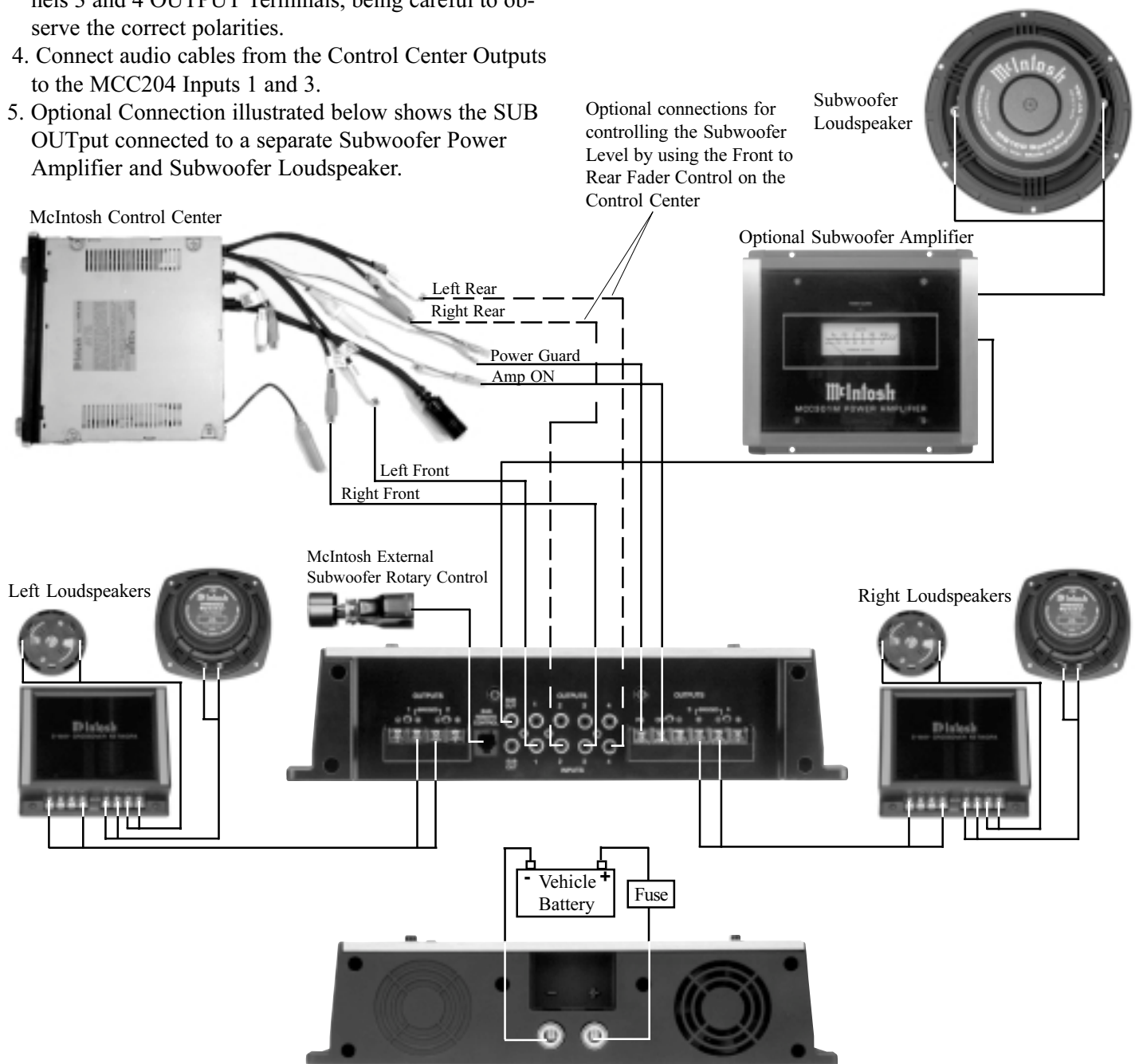

How to Connect with Subwoofer Channel

1. Connect a wire from the Control Center Amp On to the MCC204 ON Connector on the right side of the amplifier.
Note: All cables should be connected to the amplifier before connecting the DC power cables to the battery.
2. Connect a wire from a McIntosh Control Center with Power Guard to the MCC204 PG Connector on the right side of the amplifier.
3. Connect cables (up to 12AWG) from two separate upper range loudspeakers, to the Amplifier's Channels 1 and 2 OUTPUT Terminals, and subwoofer loudspeaker to Channels 3 and 4 BRIDGED OUTPUT Terminals, being careful to observe the correct polarities.
4. Connect audio cables from the Control Center Outputs to the MCC204 Inputs 1 and 2.

Note: The Subwoofer Output Signal is at line-level, summed from all the Input Channels and is available regardless of the MCC204 Operating Mode used. The Subwoofer Output Level can be remotely controlled by the optional McIntosh External Subwoofer Rotary Control connected to the SUB REMOTE CONTROL jack on the MCC204.

5. Connect the MCC204 to the vehicle battery terminals using size 4AWG (Maximum) cables.

Note: It is advisable to place an inline fuse of a suitable size as close as possible to the battery.

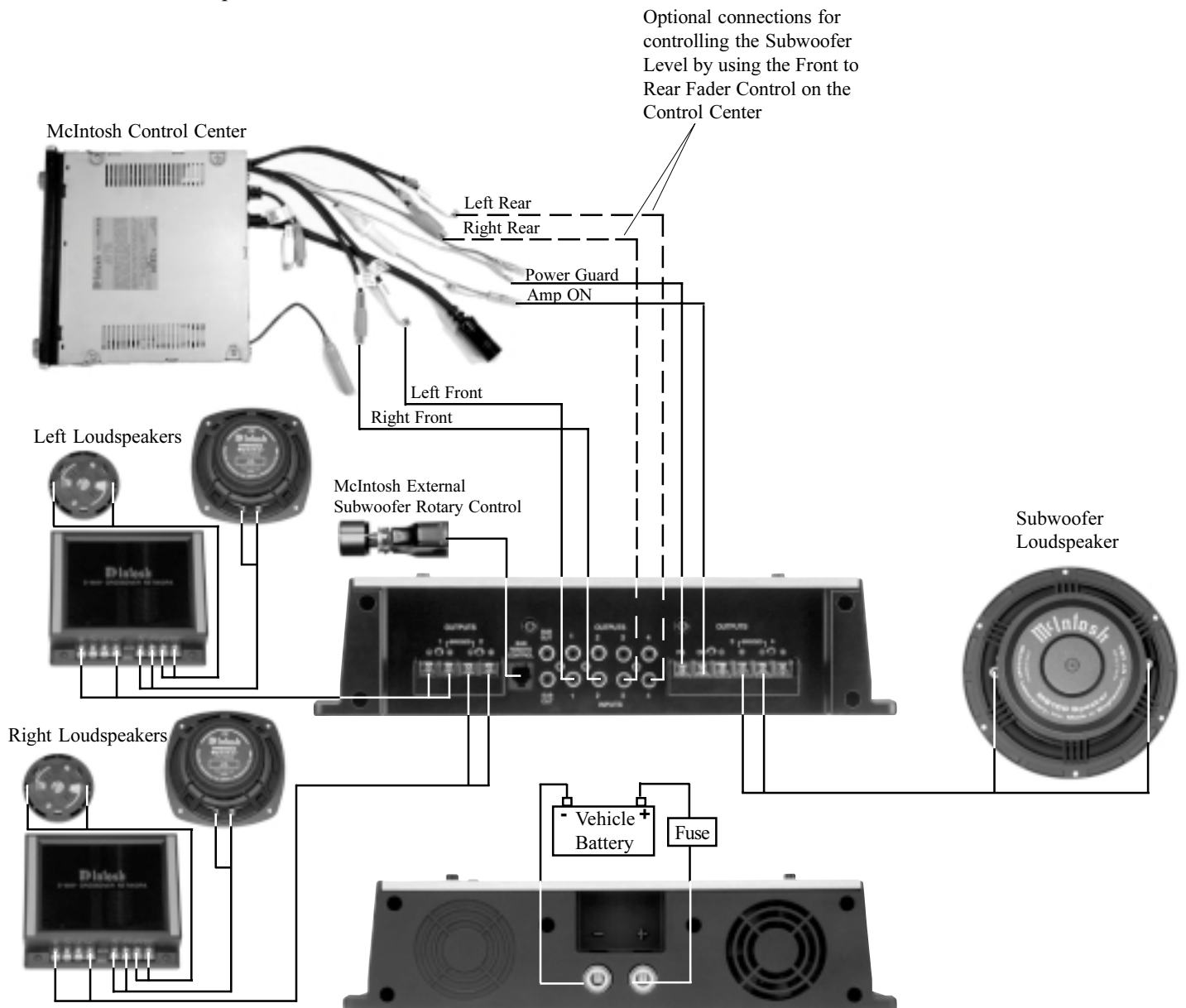

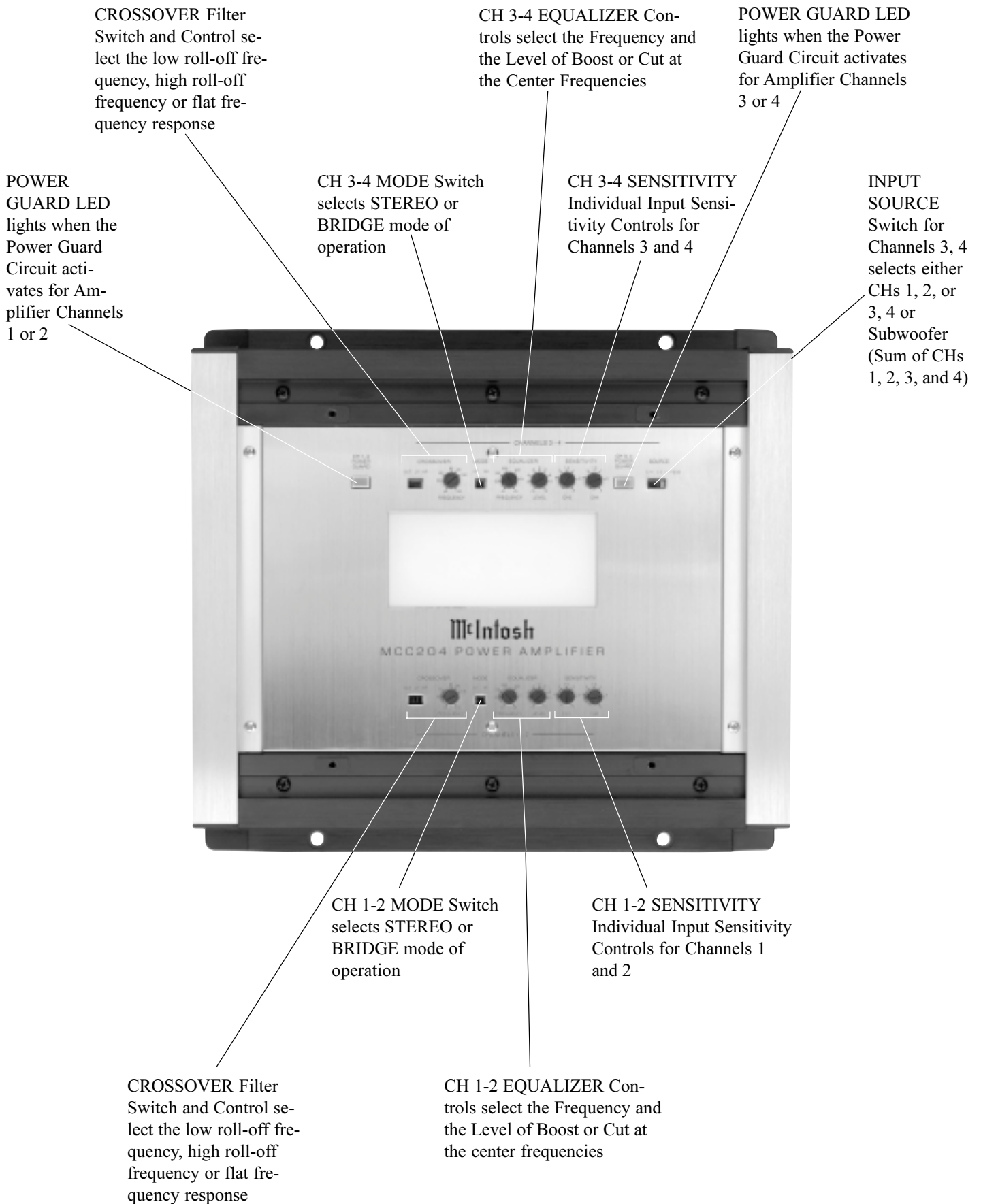

Introduction

The McIntosh MCC204 is a highly versatile amplifier that can be configured in many ways. This manual gives examples of some of the most common configurations. The best way to set equalization and filter controls is through the use of a real-time spectrum analyzer and the expertise of a professional installer. This manual will guide you through the basic operation, however we suggest you refer to your dealer for further information on the use of this unit. To access the Amplifier Controls and Switches refer to “Removing the Glass Panel” located on page 6 of this Owner’s Manual.

Crossover

The CROSSOVER Switch OUT Position selects a Flat Frequency Response. When the CROSSOVER Switch is in the LP (low frequency pass) Position, the Amplifier will pass all frequencies below the setting of the CROSSOVER FREQUENCY Control. If the CROSSOVER Switch is in the HP (high frequency pass) Position, the Amplifier will pass all frequencies above the setting of the CROSSOVER FREQUENCY Control. Refer to figure 4.



Figure 4

Equalizer

Each of the two pairs of channels (1 and 2, 3 and 4) is equipped with an equalizer. The equalizer is not intended to act as a *tone* control. The one-band equalizer is best utilized as a notch filter to reduce a peak (as located by real-time analysis with an RTA) in your system’s frequency response. If you are attempting to equalize a system without RTA data, play music you are familiar with, set the equalizer LEVEL Control to +12 and slowly turn the FREQUENCY Control to get an idea where in the musical spectrum the frequency numbers are located. Then set the LEVEL Control back to 0 and listen to the system to determine its equalization needs. Subtle adjustments are best and cutting usually sounds better than boosting. Refer to figure 5.



Figure 5

Input Sensitivity Controls

The SENSITIVITY controls allows the setting of the input sensitivity, of all four amplifier channels, to provide an ideal match for the signal source being used. The most desirable setting allows the control center to have a useful volume range as wide as possible from loud to soft. A good place to start is to set the amplifier’s SENSITIVITY Control to the output voltage called out in your control center owner’s manual. The Level controls can be set for any sensitivity from .5 volts to 8 volts.



Figure 6

Refer to figure 6.

Note: When used in conjunction with a McIntosh Control Center, you may find setting the Sensitivity controls to the center detent (1.5V) works best.

How to Operate Four Channel Mode

In the Four Channel Mode, all channels operate as independent 50 watt amplifiers. A typical four channel application is to drive a pair of full range loudspeakers in the front section of a vehicle and a second pair in the rear. Refer to figures 7 and 8.

Power

The MCC204 will turn On or Off when the Control Center turns On or Off.

Note: There must be an Amp ON connection between the MCC204 and the signal source unit in order for the amplifier power turn On and Off to function.

Input Source

Set the Input SOURCE Switch to the 3, 4 position for 4 Channel Mode.

Sensitivity Controls

The Sensitivity Controls allow setting of the input level of all four amplifier channels to provide an ideal match for the signal source being used.

Mode

Set both MODE Switches to the STereo position to configure the amplifier for four channel operation.

Crossover

Set the CROSSOVER Switches to the OUT position since all channels are operating at full frequency range.

How to Operate Three Channel Mode

In the Three Channel, Tri-amp Mode, channel 1 operates as a 50 watt amplifier for the tweeter, channel 2 operates as a 50 watt amplifier for the mid-range and bridged channels 3 and 4 operate as a 200 watt amplifier driving a woofer. Refer to figures 7 and 8.

Power

The MCC204 will turn On or Off when the control center turns On or Off.

Note: There must be an Amp ON connection between the MCC204 and the signal source in order for the amplifier turn On and Off to function.

Input Source

Set the Input SOURCE Switch to 3, 4.

Sensitivity Controls

The Sensitivity Controls allow setting the input level of amplifier channels 1, 2 and 3 to provide an ideal match for the signal source being used. Sensitivity Control 3 adjusts the woofer level balance and Sensitivity Control 4 has no effect.

Mode

Set the Channels 1-2 MODE Switch to the STereo position. Set the Channels 3-4 output MODE Switch to the BRidged position.

Crossover

Set the CROSSOVER Switches to the OUT position since all channels are operating at full frequency range.



Figure 7



Figure 8

How to Operate in Two Channel Mode

In the Two Channel Mode, Channels 1 and 2, and Channels 3 and 4 operate in bridged configuration as a pair of full frequency range 200 watt amplifiers. A typical application is use of a more powerful amplifier for stereo reproduction. Refer to figures 7 and 8.

Power

The MCC204 will turn On or Off when the Control Center turns On or Off.

Note: There must be an Amp ON connection between the MCC204 and the signal source unit in order for the amplifier power turn On and Off to function.

Input Source

Set the Channel 3-4 SOURCE Switch to 3, 4.

Sensitivity Controls

The Sensitivity Controls 1 and 3 allow the setting of input level of both bridged pairs of amplifier channels to provide an ideal match for the signal source being used.

Mode

Set both the Channel 1-2 MODE Switch and the Channel 3-4 MODE Switch to the BRIdged position to configure the amplifier for two channel operation.

Crossover

Set the CROSSOVER Switches to the OUT position since both bridged channels are operating at full frequency range.

How to Operate in Subwoofer Mode

In the Sub Woofer Mode, Channels 1 and 2 operate as independent 50 watt amplifiers, driving two midrange and high frequency or full range speakers. Channels 3 and 4 operate in Bridged Mode as a single 200-watt amplifier, driving a low frequency speaker. A typical Subwoofer Application is to drive two upper-range loudspeakers and one woofer or subwoofer. Refer to figures 7 and 8.

Power

The MCC204 will turn On or Off when the Control Center turns On or Off.

Note: There must be an Amp ON connection between the MCC204 and the signal source unit in order for the amplifier power turn On and Off to function.

Input Source

Set the Channel 3-4 SOURCE Switch to the 1-4 (SUB) position to send the summed signals from Input 1 and 2 to the Bridged Channels 3 and 4 for low-pass filtering.

Sensitivity Controls

The Sensitivity Controls allow setting the input level of Amplifier Channels 1, 2 and 3 to provide an ideal match for the signal source being used. Sensitivity Control 3 adjusts the subwoofer level balance and Sensitivity Control 4 has no effect.

Output Mode

Set the Channels 1-2 MODE Switch to the STereo position and the Channels 3-4 MODE Switch to the BRIdged position to operate in the Subwoofer Mode.

Crossover

Set the Channel 1-2 CROSSOVER Switch to the HP Position and the Channel 3-4 CROSSOVER Switch to the LP Position. Adjust the CROSSOVER FREQUENCY Control for both Channels 1-2 and 3-4 to the same frequency setting. The selection of the Crossover Frequency should be determined by the recommendations of the Loudspeaker Manufacturer for the best performance.

How to Replace the Fuses

If the MCC204 produces no sound, there is no illumination of the Nomenclature on the Top Glass Panel, and the power connections seem secure, one or more of the Amplifier's Fuse(s) may have failed. Under normal operating conditions your amplifier's fuses should not fail. Failure of a fuse is usually an indication of a problem. Replacing the fuse, if there is a problem in the amplifier, may incur a risk of further damage. Refer to figures 9, 10 and 11.

Caution: Disconnect the Amplifier from the Vehicle Battery (or DC Power Supply) as Potentially Dangerous Currents exist inside the amplifier.

1. Before accessing fuses, disconnect both the positive and negative power cables from the DC input terminals on the left side of the amplifier using a 5/32" hex key.
2. Remove the Top Glass Panel by first removing the four hex bolts with the supplied 3/32" hex key.
3. To remove the Top Glass Panel, attach the supplied suction cup to the top center of the glass panel and carefully raise it high enough to put your hand under. Temporarily place the removed glass panel in a safe place, remove the suction cup and save it for future use.
4. Remove the Phillips Screws holding the End Caps on both sides of the amplifier and lift the end caps off.
5. Remove the two Phillips Screws located between the row of Controls/Switches and the Top/Bottom edge of the Gold Faceplate Control Panel.
6. Remove all 10 crossover, equalizer and sensitivity knobs.
7. Remove the Gold Faceplate Control Panel.
8. Remove the fuses with needle nose pliers, taking care to avoid hitting parts on the circuit board.

Note: To determine if the fuse has failed, examine the link between the two fuse legs to see if it has a break in it.

9. Replace the fuse with one of the same type and rating, as unauthorized substitutions may prove hazardous to you and the amplifier.
10. When reinserting the fuse, set it in place with the pliers, then push it the rest of the way in with your finger to avoid having the pliers slip and hit the circuit board.
11. Re-install the Gold Faceplate Control Panel and all 10 crossover, equalizer and sensitivity knobs.
12. Re-connect the power cables to the vehicle battery.

If the replacement fuse(s) fails again, have the amplifier repaired at a McIntosh Service Center.

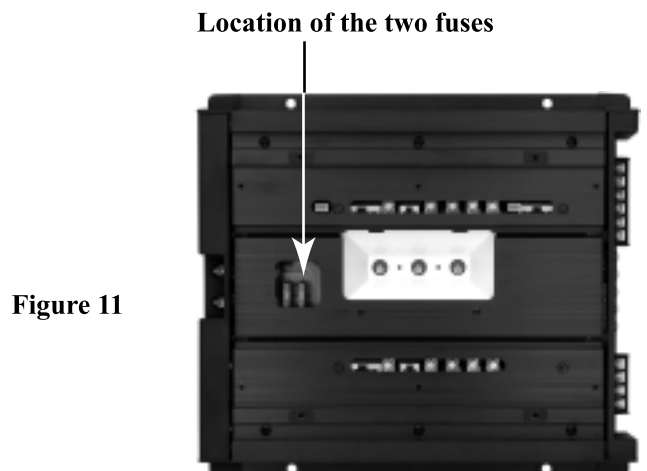
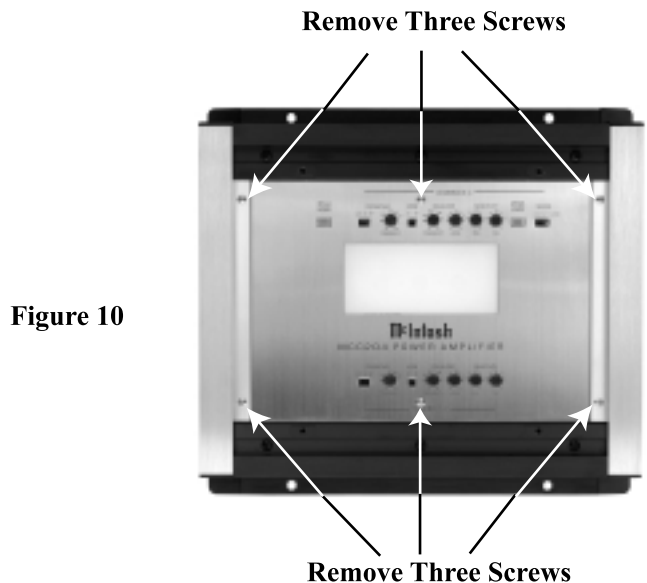
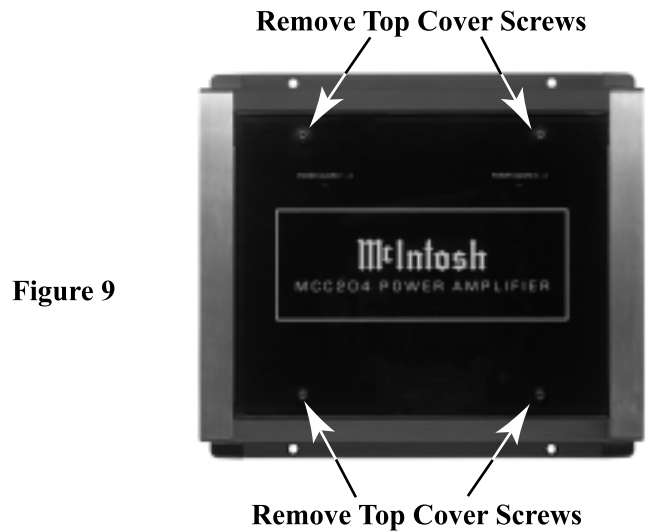

MCC204 Block Diagram

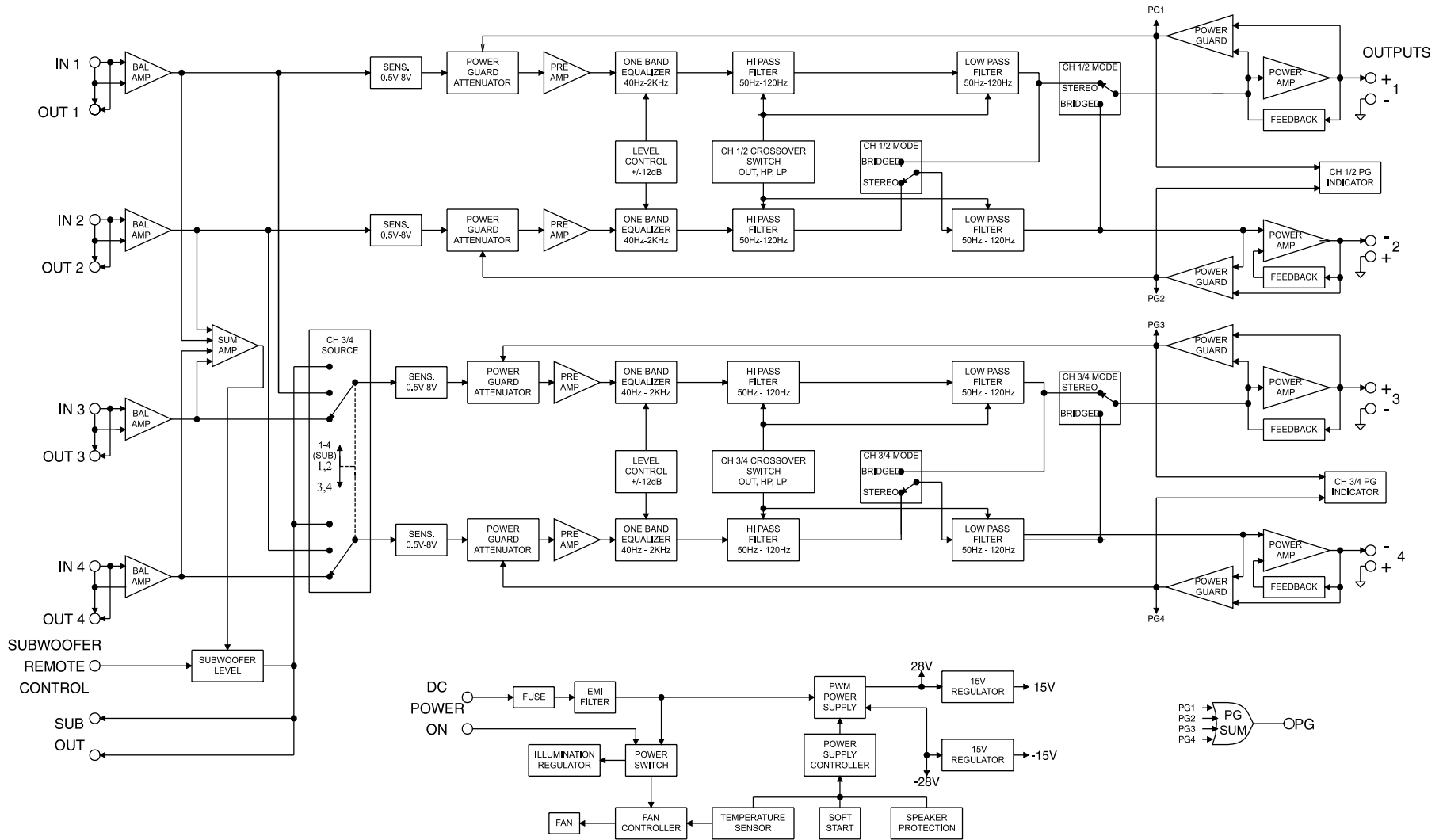

Specifications

Power Output Per Channel

50 watts into 4 ohm loads and 100 watts into 2 ohm loads is the minimum sine wave continuous average power output per channel all four channels operating.

Power Output Bridged

200 watts into 4 ohm loads is the minimum sine wave continuous average power output.

Rated Power Band

20Hz to 20,000Hz

Total Harmonic Distortion

Maximum Total Harmonic Distortion at any power level from 250 milliwatts to rated power output is:

0.005% for 4 ohm loads

0.01% for 2 ohm loads

0.01% for Bridged Mode with 4 ohm loads

Dynamic Headroom

1dB

Frequency Response

+0, -0.25dB from 20Hz to 20,000Hz

+0, -3dB from 10Hz to 100,000Hz

Sensitivity

0.5 Volts

A-Weighted Signal To Noise Ratio

105dB (1.5V)

One Band Equalizer

Center Frequency is variable from 40Hz to 2,000Hz, level variable ± 12 db, Q fixed at 2

Crossover

Selectable High pass or Low pass. The frequency is variable from 50Hz to 120Hz. The slope is 12dB per octave (Low pass is 24dB per octave in bridged mode)

Subwoofer Output

Low Pass filtered at 200Hz with a 6db per octave slope (level variable ± 12 db when using optional McIntosh External Subwoofer Rotary Control)

Intermodulation Distortion

Maximum Intermodulation Distortion if instantaneous peak output per channel does not exceed twice the rated output, for any combination of frequencies from 20Hz to 20,000Hz, with all channels operating is:

0.005% for 4 ohm loads

0.01% for 2 ohm loads

0.01% for Bridged Mode with 4 ohm loads

Input Impedance

12,000 ohms

Power Requirements

12 Volts DC, 2.5 amps (idle) - 38 amps (50 watts)

Dimensions

12.5 inches (31.8cm) wide, 3.0 inches (7.6cm) high, 13.7 inches (34.8cm) depth

Weight

14.5 pounds (6.6Kg) net, 17.0 pounds (7.7Kg) in shipping carton

Packing Instructions

In the event it is necessary to repack the equipment for shipment, the equipment must be packed exactly as shown below, failure to do so will result in shipping damage.

Make sure that the Top Glass Panel is firmly secured to the chassis using the supplied hex head screws.

Use the original shipping carton and interior parts only if they are all in good serviceable condition. If a shipping carton or any of the interior part(s) are needed, please call or write Customer Service Department of McIntosh Laboratory. Please see the Part List for the correct part numbers.

<u>Quantity</u>	<u>Part Number</u>	<u>Description</u>
1	034162	Shipping carton only
2	034132	End cap (Foam pad)

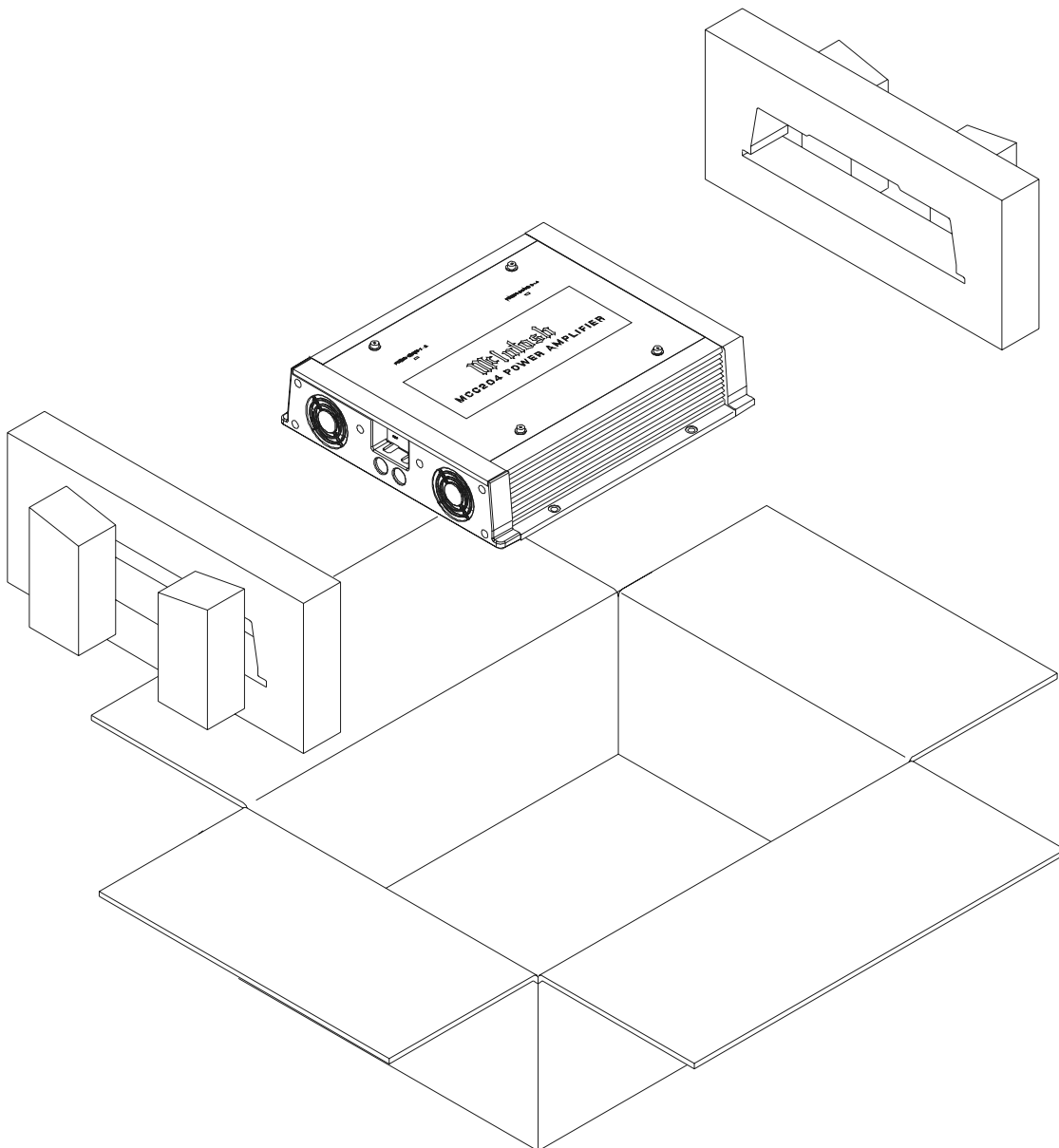

McIntosh[®]

McIntosh Laboratory, Inc.
2 Chambers Street
Binghamton, NY 13903

McIntosh Part No. 040765